

## Operating instructions

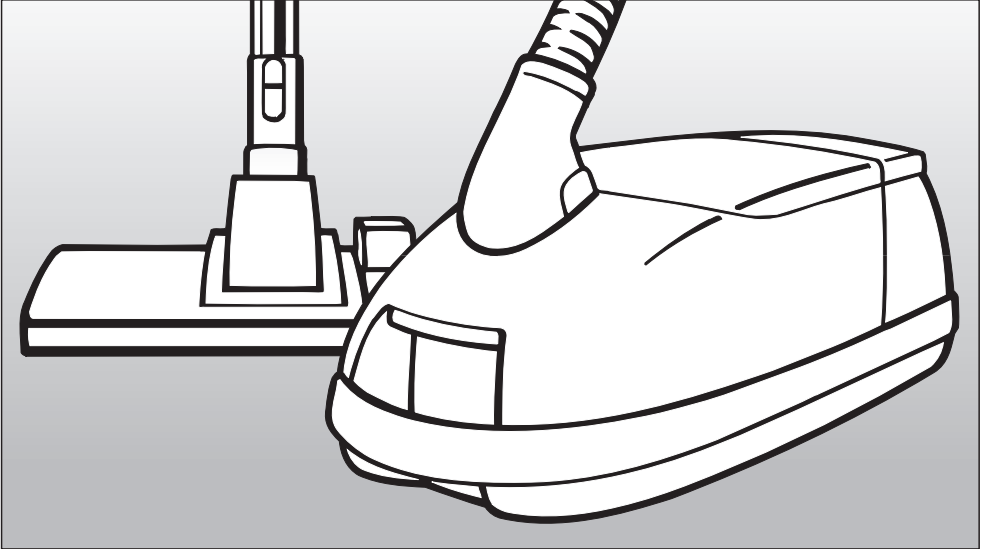

### Vacuum cleaners S 556 / S 558 S 658

These operating instructions apply to standard models S 556 / S 558 and S 658 as well as to other models with particular names rather than model numbers.



# Contents

---

<b>Caring for the environment</b> . . . . .	3
<b>Description of the appliance</b> . . . . .	4
<b>Warning and Safety instructions</b> . . . . .	6
<b>Preparing for use</b> . . . . .	9
<b>Accessories supplied</b> . . . . .	14
<b>Using the accessories supplied</b> . . . . .	16
Crevice nozzle . . . . .	16
Crevice nozzle extension . . . . .	16
Dusting brush . . . . .	17
Upholstery nozzle . . . . .	17
<b>Use</b> . . . . .	18
Unwinding and rewinding the mains cable . . . . .	18
Auto-reverse . . . . .	18
Switching the vacuum cleaner on and off . . . . .	19
Regulating the suction . . . . .	20
<b>Switching the Electrobrush on and off</b> . . . . .	21
Blowing out . . . . .	22
<b>Setting down, transportation and storage</b> . . . . .	23
Park-system . . . . .	23
<b>Maintenance and care</b> . . . . .	24
Purchasing new dustbags and filters . . . . .	24
When to change the dustbag . . . . .	25
Replacing the dustbag . . . . .	26
When to change the exhaust filter . . . . .	27
Replacing the "ACTIVE air clean" and the "ACTIVE HEPA" filter . . . . .	28
Replacing one type of filter with another . . . . .	29
When to change the dust compartment filter (motor protection) . . . . .	30
To replace the dust compartment filter (motor protection) . . . . .	30
When to change the thread lifters . . . . .	31
To replace the thread lifters . . . . .	31
<b>Cleaning and care</b> . . . . .	32
<b>Problem solving guide</b> . . . . .	33
<b>After sales service</b> . . . . .	34
<b>Accessories available as optional extras</b> . . . . .	35
<b>Electrical connection for the UK</b> . . . . .	41

### **Disposal of packing material**

The transport and protective packing material has been selected from materials which are environmentally friendly for disposal and can normally be recycled.

Ensure that any plastic wrappings, bags etc. are disposed safely and kept out of the reach of babies and young children. Danger of suffocation!

Rather than just throwing these materials away, please ensure they are offered for recycling.

### **Disposal of your old appliance**

Old appliances may contain materials which can be reclaimed or recycled. Please contact your dealer, your local waste collection centre or scrap merchant about potential recycling schemes.

Before disposing of an old appliance first make it unusable. Disconnect it from the mains, cut the cable off the appliance as close to the cleaner as possible and cut the plug off. The plug cut from the cable should be rendered useless and then disposed of and on no account be inserted into any socket elsewhere in the house (electric shock hazard).

Make appropriate arrangements for its safe disposal and make sure that the appliance presents no danger to children while being stored for disposal.

### **Disposing of the dustbag and filters**

These are made from environmentally friendly materials and can be disposed of with the normal household waste.

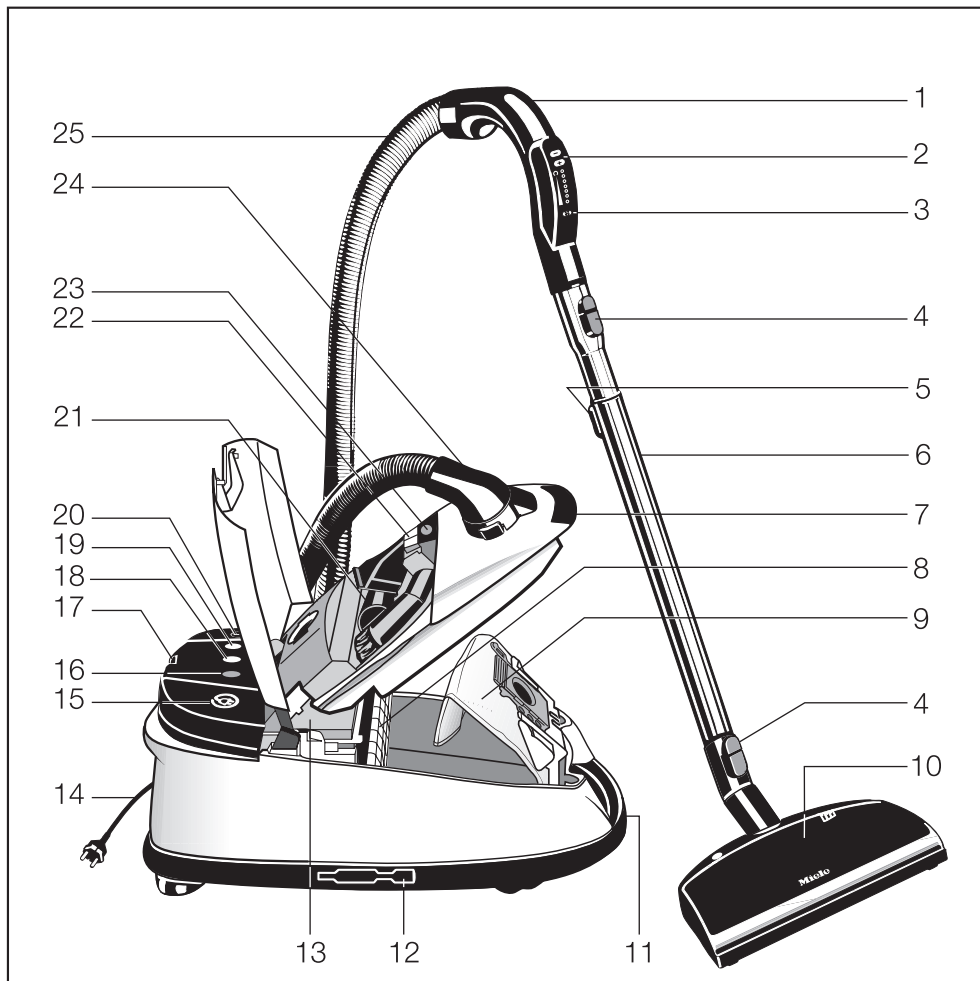

The dustbag should only be disposed of in this way if it has been used exclusively for general household dust.

## Description of the appliance



## Description of the appliance

---

- 1 Hand piece
- 2 Suction power selector
- 3 Electrobrush switch
- 4 Locking button
- 5 Electro-telescopic tube release button
- 6 Electro-telescopic tube
- 7 Dust compartment lid catch
- 8 Dust compartment filter (motor protection)
- 9 Dustbag
- 10 Electrobrush
- 11 Carrying handle
- 12 Two point holder for suction tube
- 13 Exhaust filter \*
- 14 Mains cable with plug \*\*
- 15 Cable rewind
- 16 Exhaust filter change indicator (Re-set button )
- 17 Park-system for suction tube with floorhead
- 18 Stand-by light
- 19 Overheating warning light 
- 20 On-Off switch
- 21 Accessories compartment
- 22 Dustbag change indicator
- 23 Release button for accessories compartment
- 24 Electro-elbow
- 25 Electro-suction hose

\*\* N.B. Plug may vary depending on country

The illustration shows the maximum number of features available on these Miele vacuum cleaners. Those features marked \* depend on the model and may vary or not be available on your model.

# Warning and Safety instructions

---

This appliance meets statutory safety requirements. Inappropriate use can however lead to personal injury and damage to property. Read the operating instructions carefully before starting to use this appliance. They give important information on the safety, operation and care of the appliance. This way you will prevent the risk of accidents or damage to the appliance. Please keep these operating instructions in a safe place for reference, and pass them on to any future users.

## Correct usage

■ This vacuum cleaner must only be used in a domestic household situation to vacuum **dry** floor surfaces. Do not use on people or animals.

Any other usage is at the owner's risk and could be dangerous.

The manufacturer cannot be held responsible for damage resulting from improper or incorrect use of the appliance.

## Children

■ Do not let small children play with the appliance or operate it. Please supervise its use by older children and the elderly or infirm.

## Before using for the first time

■ A damaged vacuum cleaner can be dangerous. Check the packaging, the vacuum cleaner and accessories for any signs of damage. Do not use a damaged appliance.

■ Ensure that the connection data on the data plate (voltage and frequency) match the mains electricity supply. It is essential that they match to avoid damage to the appliance.

■ The plug must be fitted with a 13A fuse (UK).

## Daily use

■ It is important to switch the vacuum cleaner off before changing over accessories and floor heads, especially a turbo or electro brush.

■ To avoid the risk of damage, do not use the vacuum cleaner without the dustbag, dust compartment filter and exhaust filter in place.

■ If a dustbag is not inserted, the dust compartment cover does not normally close. Do not force it.

■ There is a metal inlay underneath the handle, which is designed to protect the user from electrostatic discharges. Please make sure that you keep your hand in constant contact with this metal strip during vacuuming. This way any build-up of electrostatic charge will be rendered ineffective.

# Warning and Safety instructions

---

Do not vacuum up liquids or damp dirt. This will cause major faults and could seriously impair the functioning and electrical safety of the appliance. Wait until any freshly cleaned or shampooed carpets or floor coverings are completely dry before attempting to vacuum.

Do not vacuum up anything which has been burning or is still glowing e.g. cigarettes, ashes or coal, whether glowing or apparently extinguished. The cleaner might catch fire.

Do not vacuum toner dust. Toner, such as that used in printers and photocopiers can conduct electricity. The filter system in the vacuum cleaner may not filter it completely and so the toner could be blown back into the atmosphere by the fan.

Do not vacuum up any inflammable or combustible liquids or gases and do not vacuum in areas where such substances are stored. The cleaner might explode.

Do not vacuum up items which are heavy, hard or have sharp edges. They could cause a blockage and damage the appliance.

Floor attachments, accessories and tubes must not be used at head level to avoid the risk of injury, e.g. to eyes and ears.

Do not carry the appliance by the cable. When disconnecting from the mains socket pull by the plug not by the cable.

- Keep the cable away from sharp edges and do not let it be squashed at all, for example, under a door.
- Avoid running the vacuum cleaner over the cable.

A damaged cable, plug or socket is a danger of safety. The appliance must not be used if any of these have suffered damage.

Monitor the change dustbag indicator and change the dustbag if necessary. Check the exhaust and dust compartment filters at the same time and change them too if necessary. A full bag or blocked filter will hamper the suction power of the cleaner. A temperature limiter switches the vacuum cleaner off automatically if it gets too hot, see section "Problem solving guide".

Do not use aroma capsules if your cleaner is fitted with an ACTIVE HEPA filter or an ACTIVE air clean filter. The active charcoal layer in the filter will absorb the aroma from the capsules rendering them ineffective.

# Warning and Safety instructions

---

## Using accessories

■ To avoid the risk of injury when vacuuming with a Miele Electro- or Turbobrush do not touch the rotating roller brush.

■ The Miele Electrobrush is a motor driven accessory appliance for use only with Miele vacuum cleaners. The cleaner must not be used with an electrobrush produced by another manufacturer.

■ It is not advisable to vacuum directly with the handle, i.e. without an accessory attached as the rim could get damaged and you could hurt yourself on sharp edges.

■ Miele vacuum cleaner bags are disposable and intended to be used only once. Do not attempt to re-use. Blocked pores reduce the efficiency of the cleaner.

■ Use only genuine Miele dustbags, filters and accessories. This ensures optimum performance of the vacuum cleaner throughout its life.

## Cleaning, maintenance and repairs

■ Always disconnect the vacuum cleaner from the mains supply for maintenance work and for cleaning. Switch off at the wall socket and remove the plug. Pull on the plug and not the cable.

■ Do not let the vacuum cleaner get wet. Clean only with a dry cloth or slightly damp cloth when disconnected from the mains supply. If moisture gets

into the appliance there is the risk of an electric shock.

■ The electro-suction hose and the electro-telescopic tube contain electrical wires. The plug connectors must not come in contact with water. These items may only be cleaned with a dry cloth, no moisture must touch them. Danger of electric shock.

■ Repairs may only be carried out by a suitably qualified and competent person in accordance with national and local safety regulations. Repairs and other work by unqualified persons could be dangerous. The manufacturer cannot be held responsible for unauthorised work.

■ If the cable is damaged it should be replaced together with a complete cable rewind by a Miele service technician.

## Disposing of an old appliance

■ When disposing of an old appliance cut the cable off the appliance as close to the cleaner as possible and cut the plug off. The plug cut from the cord should be rendered useless and then disposed of and on no account be inserted into any socket elsewhere in the house (electric shock hazard). See section "Disposal of your old appliance" earlier in this booklet for further advice.

The manufacturer cannot be held liable for damage caused by non-compliance with these Warning and Safety instructions.



### Attaching the suction hose

- Open the dust compartment shutter.

The dust compartment shutter is designed for hygienic handling and prevents dust and odours escaping.

If you remove the suction hose from the vacuum cleaner for storage purposes close the dust compartment shutter before putting it away (e.g. in a cupboard).

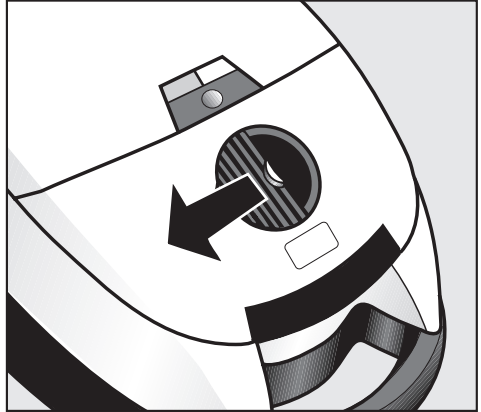

- Insert the elbow into the suction socket.

When inserting the elbow ensure that the plug connectors line up correctly.

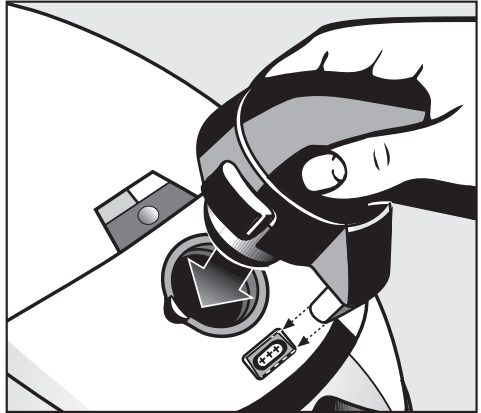

### Removing the suction hose

- Press the release buttons at the side of the elbow and lift the hose from the socket.

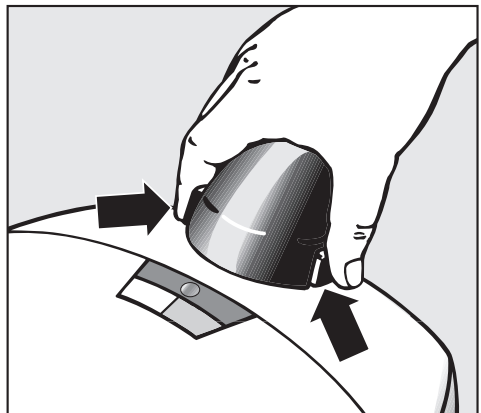

## Preparing for use

### Connecting the suction hose and the suction tube

- Fit the hand piece of the suction hose firmly into the suction tube. (Ensure that the plug connectors line up). They must lock together with a click.
- To release the hand piece from the suction tube press the locking button (see arrow) and pull the hand piece away from the suction tube.

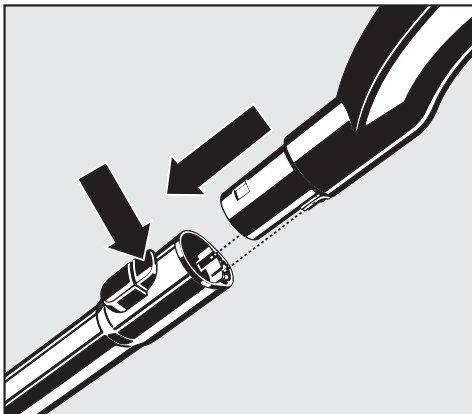

### Adjusting the electro-telescopic suction tube

One part of the electro-telescopic tube is packed inside the other and can be adjusted to suit your height for comfortable vacuum cleaning.

- Press the telescopic tube release button (see arrow) to release the tubes. Draw out or push in the inner tube to adjust to the required height, then release the button. The tube is locked in position.

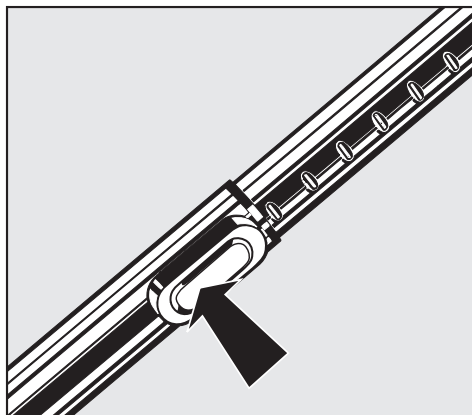

 When a resistance is felt it has reached its maximum length. Do not force it beyond this length!

### Using the Electrobrush

The Electrobrush is particularly suitable for intensive vacuuming of carpets which are subject to hard wear. It is very effective at removing deep seated dirt and preventing areas of frequent use being trodden into a path.

It is also important to observe the flooring manufacturer's cleaning and care instructions.

### The following should not be vacuumed using the Electrobrush

- Floor surfaces with a variable or uneven profile. The brush might come into contact with the floor and cause damage.
- Carpets such as saxony with very long pile, berber and sheepskin rugs, and valuable hand-knotted carpets, e.g. Persian and similar. There is a danger that threads can be pulled out.

### Fitting the Electrobrush to the vacuum cleaner

- Insert the electro-telescopic tube into the Electrobrush. (Ensure that the plug connectors line up). They must lock together with a click.

For further information on use and maintenance please refer to the separate instructions supplied with the Electrobrush.

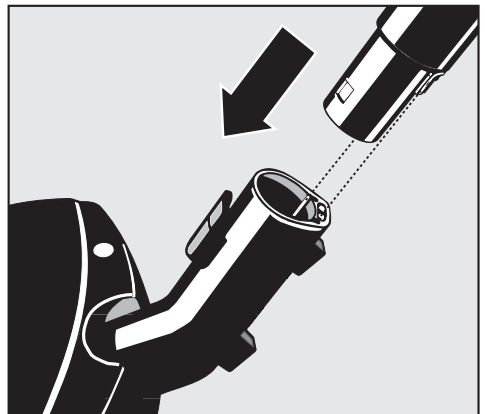

## Preparing for use

---

### Using the standard floorhead

(standard or optional accessory depending on model)

The floorhead can be used for all normal cleaning of carpets and rugs. It can also be used with the brush protruding to vacuum hard flooring which is not susceptible to scratching. For hard flooring, such as stone and floors which are susceptible to scratching, e.g. parquet, we recommend using one of the special Miele floor brushes (see "Accessories available as optional extras").

It is also important to observe the flooring manufacturer's cleaning and care instructions.

the cleaner (see "Description of the appliance", illustration point 12).

### Fitting the standard floorhead

- Push the suction tube into the floorhead and turn it clockwise or anti-clockwise until it clicks into position.
- To release the floorhead from the suction tube press the locking button (see arrow) and pull the suction tube away from the floorhead.

To carry the vacuum cleaner by the handle and for storage purposes fit adapter (A) to the standard floorhead, turbobrush or floorbrush and then fit the suction tube to the adapter. The clips on the standard floorhead, turbobrush or floorbrush can then be fitted securely into the two point holder on the side of

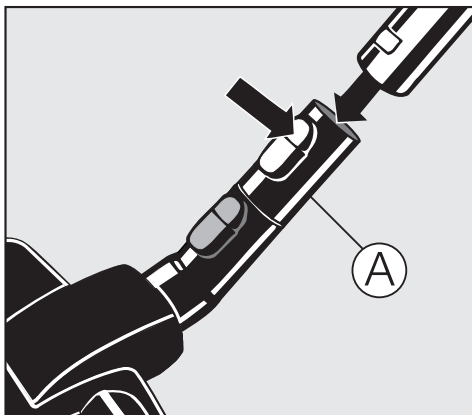

### Adjusting the standard floorhead setting

Vacuum carpets and rugs with the brush retracted:

- Press the foot switch marked .

Clean hard flooring which is not susceptible to scratching with the brush protruding:

- Press the foot switch marked .

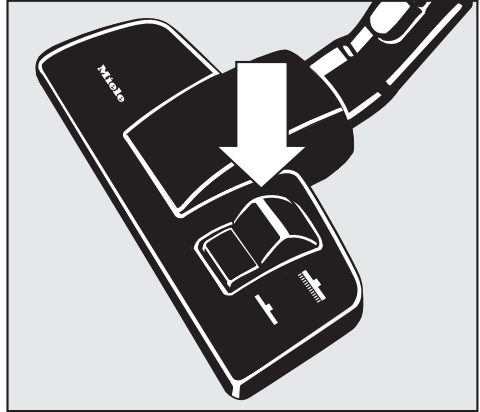

## Accessories supplied

Other tools, in addition to the floorhead(s), are supplied with the vacuum cleaner to help deal with various types of cleaning.

- ① Crevice nozzle
- ② Crevice nozzle extension \*
- ③ Dusting brush
- ④ Upholstery brush
- ⑤ Filter grille  
(supplied separately in the box)
- ⑥ Blower connection socket \*,  
not illustrated (see section "Use -  
Blowing out")

\* depending on model

The filter grille ⑤ is required if you wish to replace the "ACTIVE air clean" or "ACTIVE HEPA" exhaust filter with a "SUPER air clean" filter.

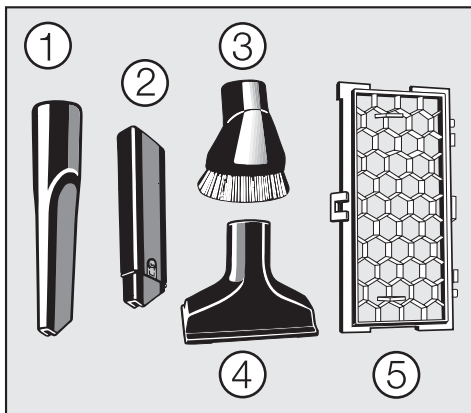

### Taking the accessories out

- Press the release button to open the accessories compartment lid.

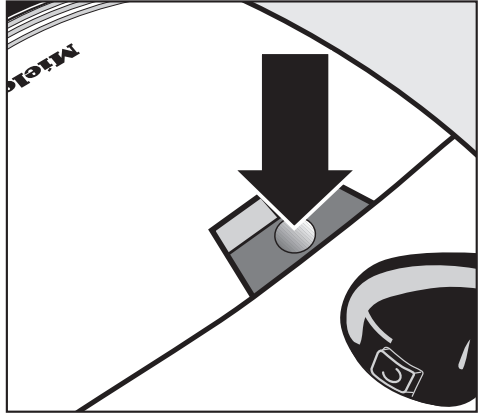

- Take out the accessory you require.
- Close the lid securely.

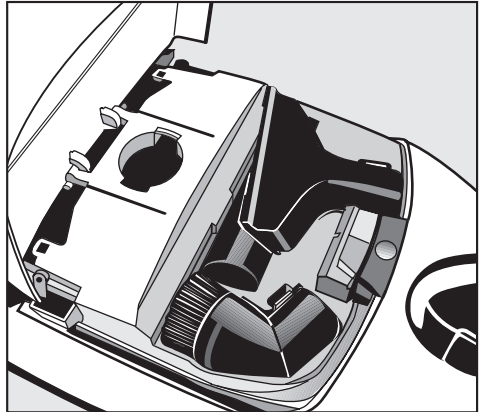

### S 658 accessories compartment

The extension for the crevice nozzle is located in the compartment underneath the crevice nozzle.

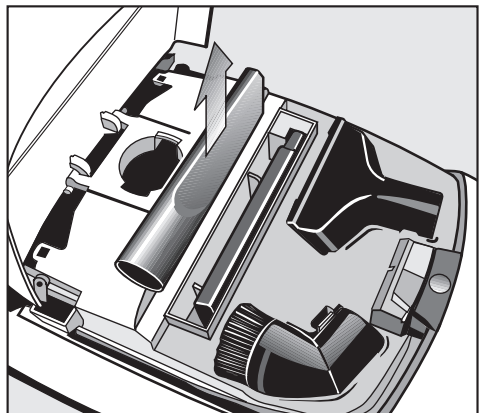

## Using the accessories supplied

---

The different tools can either be fitted to the hand-piece or, as required, to the suction tube.

### Crevice nozzle

for cleaning in folds, crevices or corners.

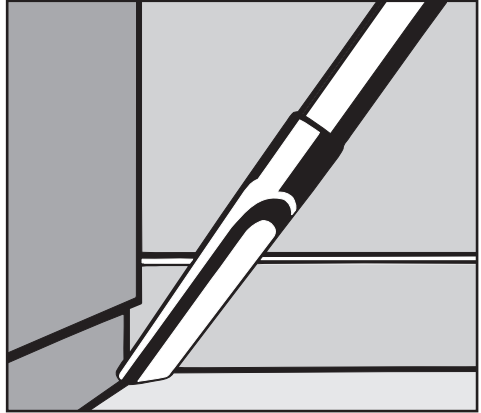

### Crevice nozzle extension

(depending on model)

This accessory can be used to extend the length of the crevice nozzle. Further length is provided by pulling out the inner section.

- Press the locking button to pull the extension piece out or to push it in.

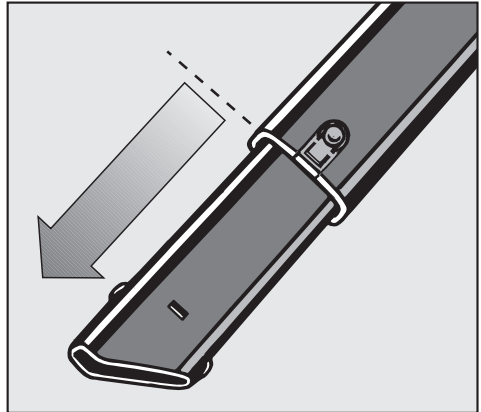



## Using the accessories supplied

---

### Dusting brush

For cleaning skirting boards, ornate or carved articles, etc.

The head of the dusting brush can be swivelled to attain the best cleaning position.



### Upholstery nozzle

For cleaning upholstery, mattresses, cushions, curtains, covers etc.



# Use

## Unwinding and rewinding the mains cable

### Unwinding

- Hold the plug and unwind cable to the required length:  
S 556 / S 558: max. approx. 7.5 m /  
S 658: max. approx. 9.5 m

 When vacuuming for longer than 30 minutes at a time, pull the cable out to at least two-thirds of its total length, even when working close to the wall socket. Otherwise there is a danger of overheating and damage.

### Rewinding

- Switch off at the wall socket and remove the plug.
- Press the rewind switch. The cable will rewind automatically.

### Auto-reverse

To switch on this function, move the slide switch to "Auto-Reverse". The rewind brake on the cable drum is released. It pays out the exact amount of cable required and gathers in excess cable so that the cable automatically adjusts itself to the distance between the appliance and the wall socket.

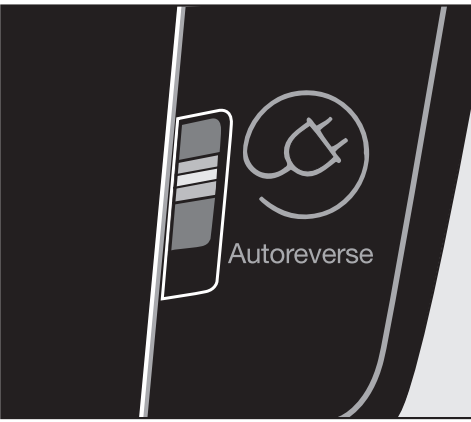
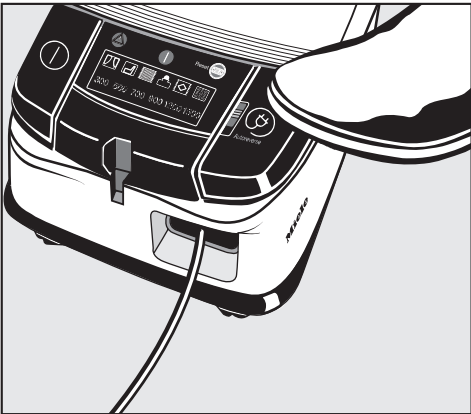
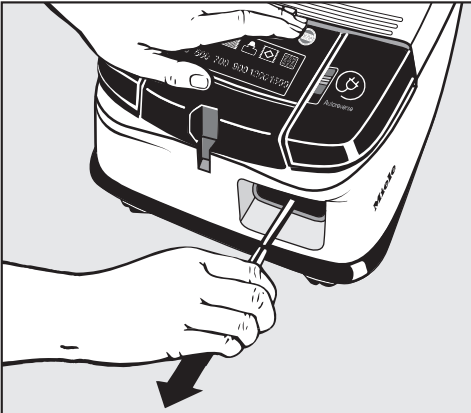

## Switching the vacuum cleaner on and off

To switch the vacuum cleaner on:

- Press the On-Off switch.

The Stand-by indicator light comes on to show that the vacuum cleaner is ready for use.

To switch the vacuum cleaner off:

- Press the On-Off switch again.

The Stand-by light goes out.

 Switch the vacuum cleaner off with the On-Off switch before opening the dust compartment lid. Otherwise the vacuum cleaner will automatically switch on when the lid is opened (this enables the blower facility to work).

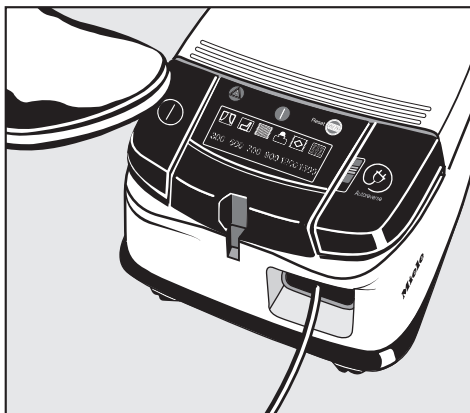

## Vacuuming

When vacuuming, especially fine dust, e.g. sawdust, sand, plaster, flour, talcum powder etc., electrostatic charges build up naturally. Under certain conditions these charges will be released. To avoid the unpleasant effects of these electrostatic discharges a metal inlay has been incorporated into the underside of the handle.

- Please make sure that you keep your hand in constant contact with this metal strip during vacuuming. This way any build-up of electrostatic charge will be rendered ineffective.
- When vacuuming pull the cleaner behind you on its castor wheels. You can stand it upright for vacuuming stairs and curtains etc.

# Use

## Regulating the suction

■ Switch on the vacuum cleaner.

Use the **+** and **-** on the hand-piece to regulate the suction to suit the type of flooring.

The higher the wattage the more powerful the suction.

Setting **0** = no suction

Low setting = weak suction

High setting = strong suction

The symbols on the controls of your vacuum cleaner indicate the type of use the settings are suitable for.

 = curtains, lightweight fabrics

 = upholstery, cushions

 = thick pile carpets, rugs and runners

 = for energy-saving daily use

 = lightly soiled textured carpets

 = textured hard flooring, and for intensive cleaning of carpets

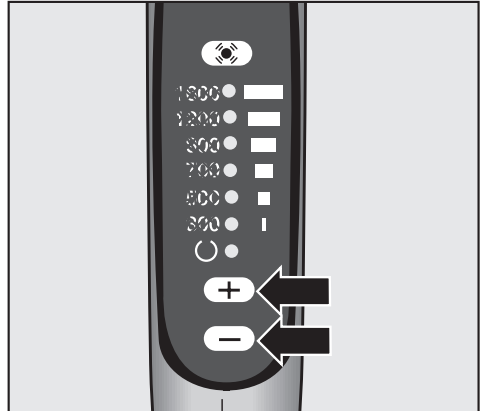

## Switching the Electrobrush on and off

The Electrobrush is switched on and off separately from the vacuum cleaner by pressing the  switch on the handpiece.

This means that you can switch the Electrobrush off during vacuuming and the vacuum cleaner will continue to operate using suction only. This is useful when moving from vacuuming a fitted carpet to a rug, for example.

Selecting setting  also switches the Electrobrush off. To continue vacuuming again select a suitable setting.

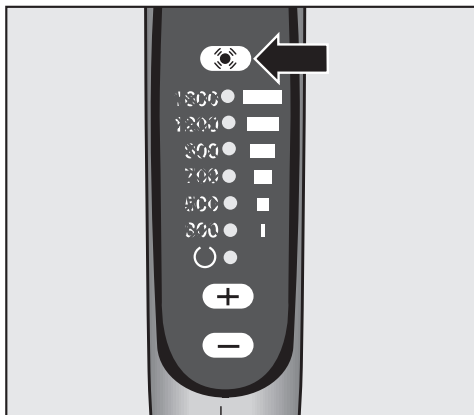

# Use

## Blowing out

### Blower connection socket

(depending on model)

The blower connection socket can be used to connect the suction hose to the "blower" outlet of the vacuum cleaner, e.g. for dusting off multi-layered radiators and blowing dust out of inaccessible corners so that it can be vacuumed up. It can also be used to "blow out" the suction hose if it should ever become blocked.

- Press the release button for the dust compartment lid and raise up the lid until it clicks into place.
- Take out the exhaust filter or the filter grille if this has been fitted and replace with the blower connection socket.
- Close the dust compartment lid.

- Now open the accessories compartment and insert the elbow of the suction tube into the blower connection socket.

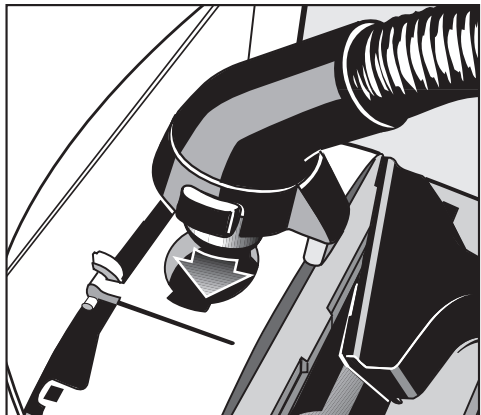
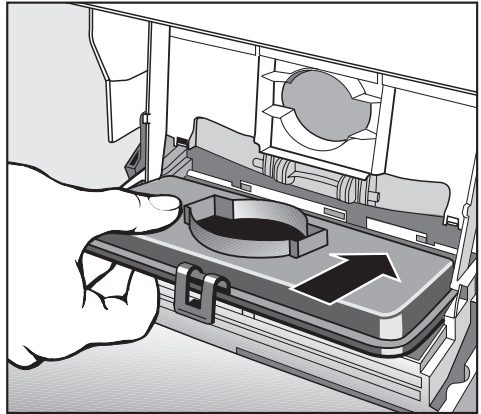
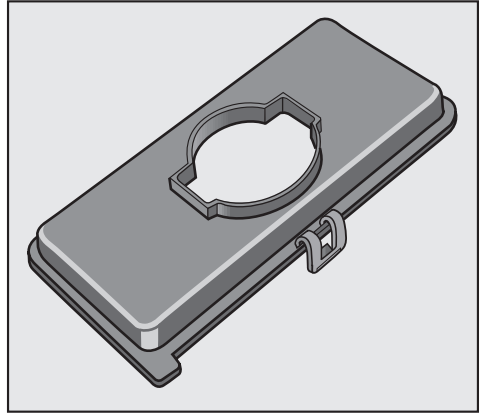

# Setting down, transportation and storage

## Park-system

A Park-system has been designed for conveniently parking the vacuum cleaner during pauses. A special parking attachment is fitted to all floorheads including the Electrobrush and to the rear of the cleaner.

- Fit the lower clip on the floorhead into the slot on the end of the vacuum cleaner from above (see illustration).

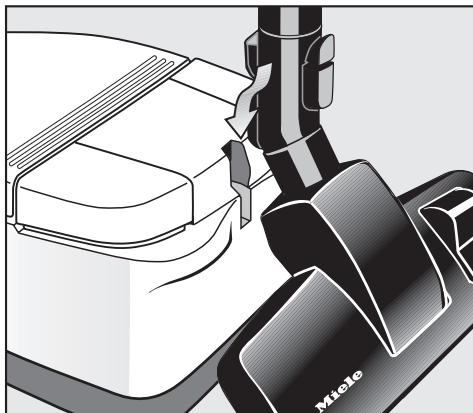

## Switching on and off with the Park-system

Parking the floorhead in this way whilst vacuuming automatically switches off the cleaner without needing to press the On-Off switch. Lifting the floorhead out of the Park-system switches the cleaner on again.

If you intend leaving your vacuum cleaner parked in this way for any length of time, you must switch it off at the socket, unplug it and rewind the mains cable.

## Transportation and storage

- Stand the vacuum cleaner vertically.
- Fit both clips on the Electrobrush into the two point holder on the side of the cleaner (use Adapter **A** with the standard floorhead, turbobrush and other floor brushes).

This makes the cleaner easier to carry or store.

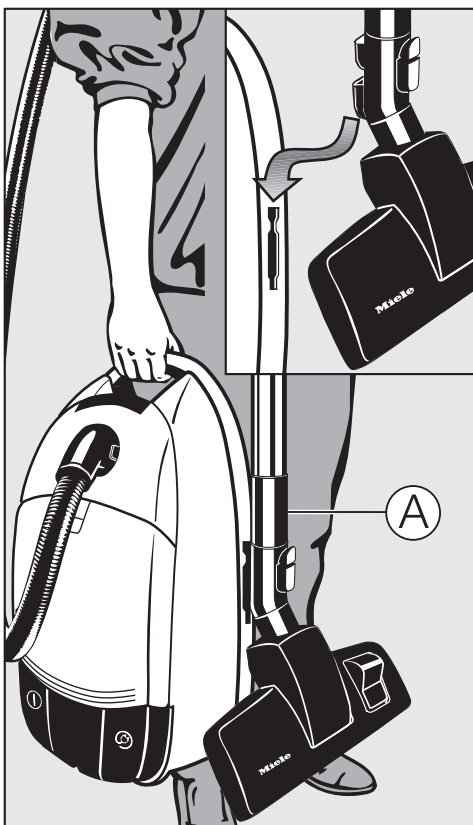

## Maintenance and care

---

 Always disconnect the vacuum cleaner from the electrical supply for maintenance work and for cleaning. Switch off at the wall socket and remove the plug.

The Miele filter system consists of three filters which must be replaced from time to time to ensure efficient suction.

- Dustbag (filter bag)
- Exhaust filter
- Dust compartment filter (for motor protection)

Use only genuine Miele dustbags and filters, making sure they are the correct ones for your model. This ensures optimum performance of the suction power and also ensures that the bag is used to capacity.

### Purchasing new dustbags and filters

Replacement dustbags and filters can be obtained from your local Miele Dealer or direct from the Miele Spare Parts Department.

Order original Miele dustbags with the letter:

- **F/J/M** for model S 556 / S 558
- **G/N** for model S 658.

Always quote the model number given on the data plate situated underneath the appliance.

A "SUPER air clean" exhaust filter and a dust compartment filter are supplied with every packet of Miele dustbags.

If you wish to purchase exhaust filters or dust compartment filters separately, please quote the model number of your appliance when ordering.

You can replace the exhaust filter supplied with the vacuum cleaner with one of the other types of filters if you wish (see "Replacing one type of filter with another").



### When to change the dustbag

Change the dustbag when the colour marker in the dustbag change indicator fills the display.

The dustbags are disposable and intended to be used only once. Do not attempt to re-use as suction would be reduced.

### Checking the dustbag change indicator

- Attach the floorhead to the vacuum cleaner. Other attachments, for example the crevice nozzle can affect the function of the dustbag change indicator. Therefore only test with the floorhead fitted.
- Switch the vacuum cleaner on and select the highest power setting.
- Lift the floorhead off the floor a little. If the marker completely fills the indicator window, then the bag needs to be changed.

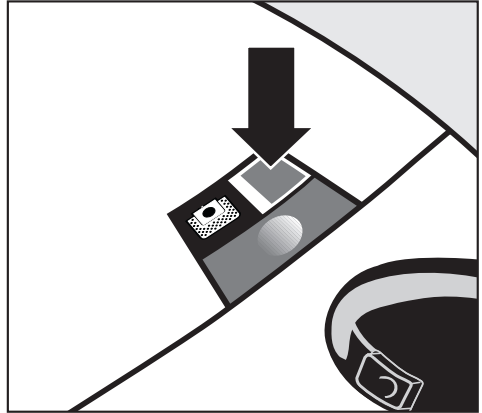

### How the dustbag change indicator works

The indicator is designed to show when the bag is full of common household dust and works by measuring the air permeability of the dustbag. Normal household dust is composed of a mixture of dust, hair, carpet fluff, threads, grit etc.

However, if an amount of fine dust, such as plaster, brick dust, cement or flour is vacuumed then the pores of the dustbag become blocked very quickly. The marker will indicate that the bag is "full" even when it is not. In this instance the dustbag must be changed as suction power is reduced when the pores of the dustbag are blocked.

If, on the other hand, a large quantity of hair, wool or carpet fluff is vacuumed, the dustbag change indicator may not register "full" even though the bag is full. This is because the air permeability of the dustbag may still be high enough not to activate the marker to show maximum. The dustbag should still be changed.

## Maintenance and care

### Replacing the dustbag

- Press the release button for the dust compartment lid and raise the lid until it clicks into place.

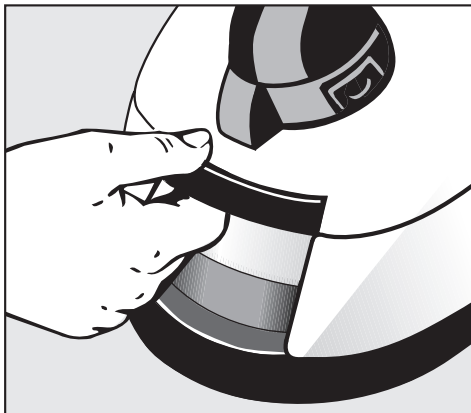

The dustbag has a closing flap which closes automatically when the dustbag is removed to prevent any dust escaping.

- Hold the bag by the collar and then pull it out of its holder.

It can then be disposed of with the normal household waste as long as it has only been used for vacuuming up normal household dust.

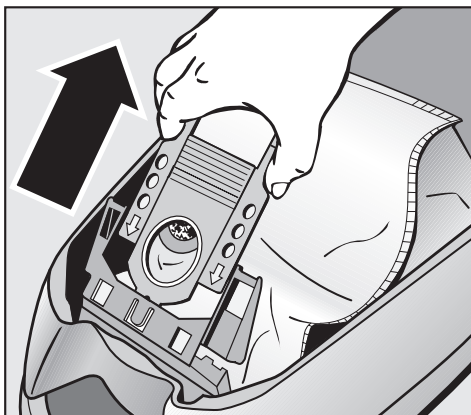

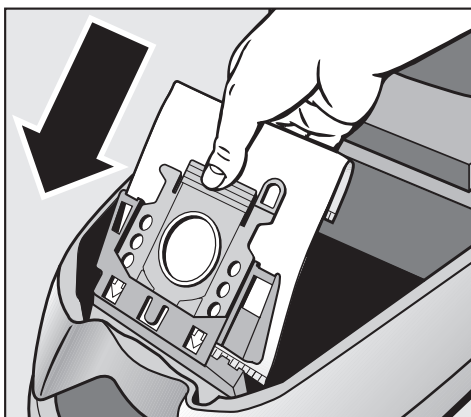

Do not unfold the bag when you take it out of the packet. Keeping it folded will prevent it from getting trapped when the dust compartment lid is closed.

- To insert a new dustbag push the collar securely into the frame as far as it will go. If it is not correctly located the dust compartment lid will not close.
- Close the dust compartment lid firmly. It should click into place.



### When to change the exhaust filter

The built-in exhaust filter change indicator (Re-set button ) is designed for the change cycle of an ACTIVE air clean or an ACTIVE HEPA filter.

Always change the filter when the exhaust filter indicator (Reset button ) lights up. It is designed to light up after approx. 50 hours of operation which is equivalent to about a year of average use. It should be replaced sooner if it is obviously soiled or no longer effective. Make a note of the date on the filter. The vacuum cleaner can still be used with the exhaust filter indicator lit up. However, the suction power will be reduced as will the effectiveness of the filter if it is not replaced in good time.

You can replace the exhaust filter supplied with the vacuum cleaner with one of the other types of filters if you wish (see "Replacing one type of filter with another").

### Re-setting the filter change indicator

The filter change indicator needs to be re-set each time the filter is replaced. To do this the vacuum cleaner must be connected to the electricity supply.

Press on the filter change indicator light until it goes out. The display is now back in the starting position again.



# Maintenance and care

## Replacing the "ACTIVE air clean" and the "ACTIVE HEPA" filter

- Open the dust compartment lid.
- Release the catch and remove the filter.

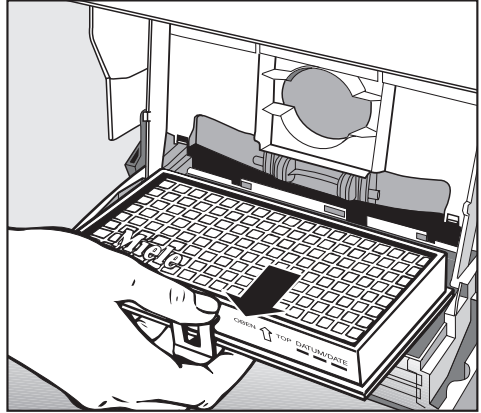

- To insert the new filter, fit it so that it engages at the back and then close the catch.
- Close the dust compartment lid firmly. It should click into place.

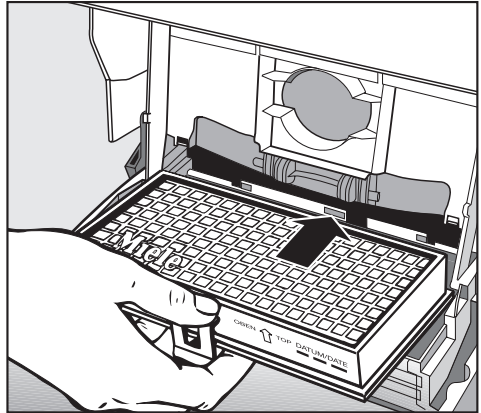

- Remember to reset the "Exhaust filter change indicator".



## Replacing one type of filter with another

Depending on model, your vacuum cleaner is fitted with one of the following exhaust filters as standard:

- b** an ACTIVE air clean filter or
- c** an ACTIVE HEPA filter.

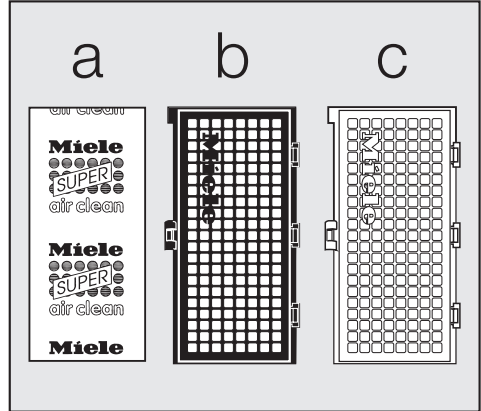

### If replacing **b** or **c** with **a**, please note

If you wish to replace the ACTIVE air clean filter **b** or the ACTIVE HEPA filter **c** with a SUPER air clean filter **a** it is essential that you also fit the filter grille (see the section on "Accessories supplied").

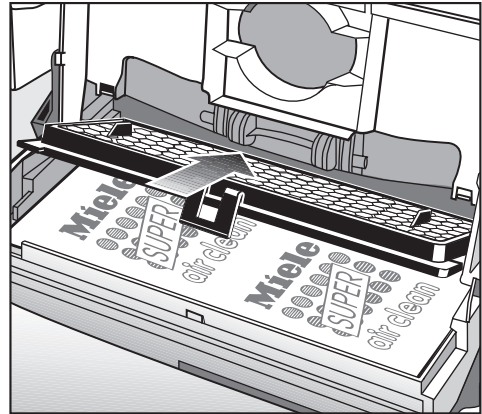

The built-in exhaust filter change indicator (Re-set button ) is designed for the change cycle of an ACTIVE air clean or an ACTIVE HEPA filter.

The filter change indicator light will have no significance if a SUPER air clean filter has been fitted, but should still be re-set. The SUPER air clean filter should be replaced with a new one every time you start a new packet of dustbags. (A SUPER air clean filter is supplied with every packet of Miele dustbags).

Remember to reset the "Exhaust filter change indicator".



## Maintenance and care

---

### When to change the dust compartment filter (motor protection)

Replace the dust compartment filter every time you start a new packet of dustbags.

A dust compartment filter is supplied with every packet of Miele dustbags.

### To replace the dust compartment filter (motor protection)

- Open the dust compartment lid.
- Unclip the filter frame, remove the old filter and replace with a new one.
- Close the filter frame.

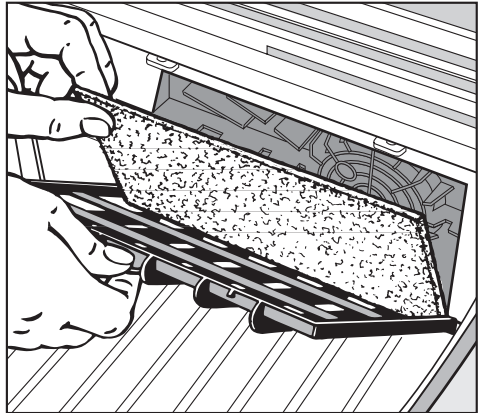

## When to change the thread lifters

Check the thread lifters on the suction inlet of the standard floorhead \* and the upholstery nozzle from time to time. Replace them if the pile is worn.

\* standard or optional accessory depending on model

## To replace the thread lifters

- Use a knife or similar object to remove them from the slots.
- Fit the new thread lifters.

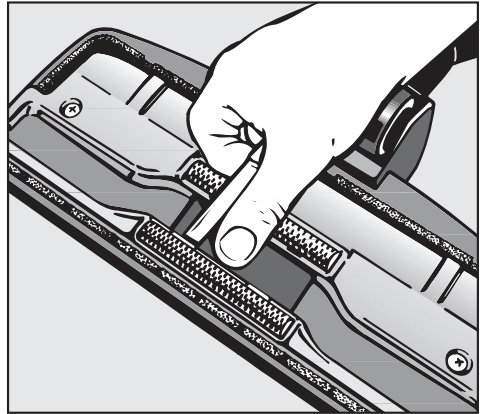

## If threads or hair have wound round the roller pin on a standard floorhead

① Use a coin to release the roller pin (bayonet connection), and pull out the pin.

② Take out the roller.

Remove all threads and hair etc., then replace the individual parts in the right order.

Spare parts are available from your Miele dealer or from the Miele Spare Parts Department.

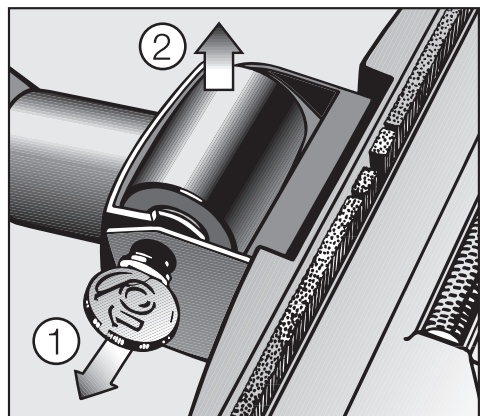

## Cleaning and care

---

 Always disconnect the vacuum cleaner from the electricity supply for maintenance work and for cleaning. Switch off at the wall socket and remove the plug (pull on the plug, not the cable).

### Vacuum cleaner and accessories

 The electro-suction hose, the electro-telescopic tube and the electrobrush contain electrical wires and components. The plug connectors must not come in contact with water. These items may only be cleaned with a dry cloth, no moisture must touch them. Danger of electric shock.

External surfaces of the vacuum cleaner and of accessories can be cleaned with a dry or slightly damp cloth or with a proprietary cleaner suitable for plastic.

 Do not use an abrasive cleaner, a glass cleaner or an all-purpose cleaner. Because of their chemical composition they could cause serious damage to the plastic casing.

### Dust compartment

The dust compartment can, if necessary, be cleaned using a **dry** duster, dusting brush or, if available, a second vacuum cleaner to suck the dust out.

Monitor the dustbag change indicator and inspect all filters regularly. Clean or replace them when necessary according to the operating instructions.

 Never dip the vacuum cleaner in water. If moisture gets into the appliance there is the risk of an electric shock.



### Overheating

A temperature limiter switches the vacuum cleaner off automatically if it gets too hot. The warning light  will then come on to indicate that it has overheated.

This can occur if, for instance, large articles block the suction tube or when the dustbag is full or contains particles of fine dust. A heavily soiled exhaust or dust compartment filter can also be the cause of overheating. In this case, please switch off the vacuum cleaner using the **On-Off** switch.

After removing the cause, wait for a period of approx. 20 - 30 minutes, so that the vacuum cleaner can cool down. It can then be switched on again.

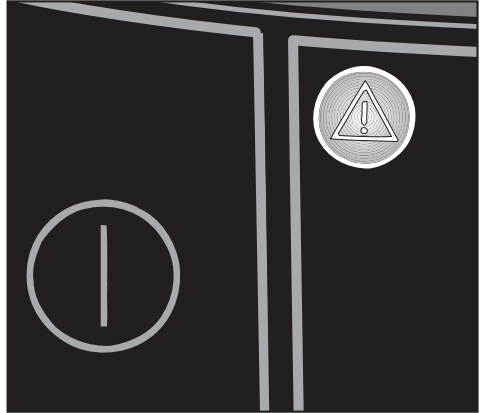

## After sales service

---

In the event of a fault that you cannot easily remedy, please contact

– your Miele Dealer

or :

– the nearest Miele Service Department. (See address on back page).

Please note that telephone calls may be monitored and recorded to improve our service.

## Accessories available as optional extras

### Turbobrush

The Turbobrush is particularly suitable for vacuuming cut pile carpeting and is operated by the suction power of the vacuum cleaner. It has a rotating brush which is very effective at picking up thread, hairs and fluff.

It is also important to observe the flooring manufacturer's cleaning and care instructions.

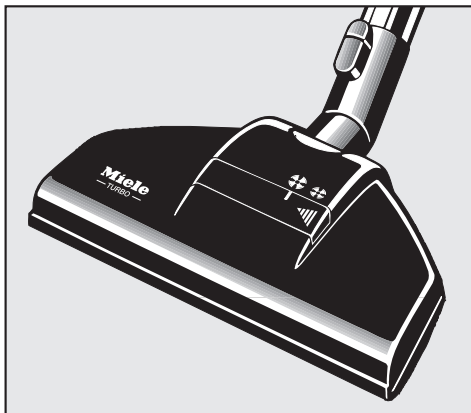

### Hand-held Turbobrush

The hand-held Turbobrush is intended for vacuuming upholstery, mattresses, car seats, carpeted stairs and other areas inaccessible to the standard Turbobrush.

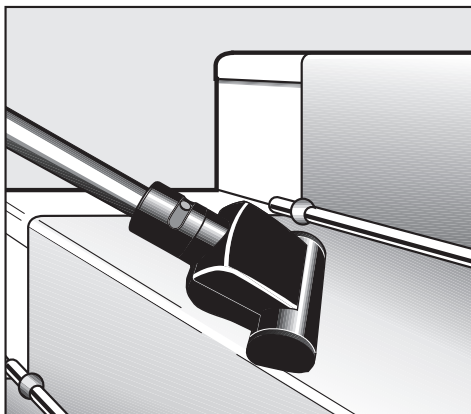

## Accessories available as optional extras

---

### CarClean Set Plus

The CarClean Set Plus has been designed for valeting the interior of cars.

It consists of:

- Hand-held Turbobrush
- Micro-hose with combination nozzle
- Crevice nozzle (300 mm long)

These are supplied in a carry case together with a 3 m long suction hose with hose clip.

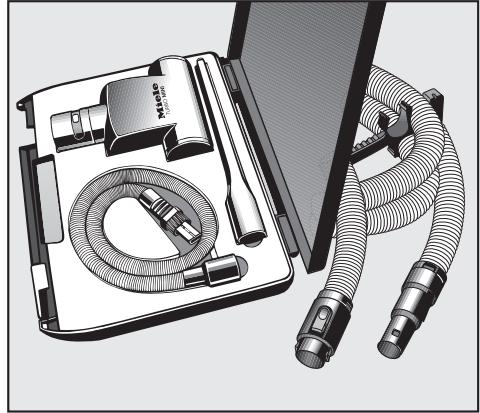

### CarClean Set Vario

The Miele CarClean Set Vario has been designed as an accessory for Miele and non-Miele cylinder vacuum cleaners.

An adapter (not shown in the illustration) is included with the CarClean Set Vario which is required for connecting the accessories to non-Miele cylinder vacuum cleaners.

It is not supplied with the 3 m long suction hose.

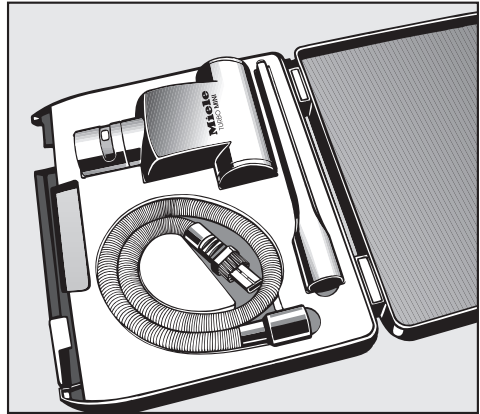

## Accessories available as optional extras

---

### Hard floor brush

for vacuuming smooth flooring, such as stone, tiles, PVC.

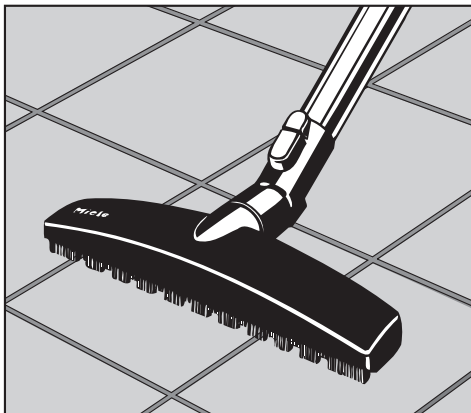

### Parquet floor brush

Special brush with genuine horsehair bristles for cleaning parquet floors, floorboards and laminate flooring which is susceptible to scratching.



## Accessories available as optional extras

---

### Radiator brush

For cleaning radiators, narrow shelves or crevices.

- Fit the radiator brush to the crevice nozzle.

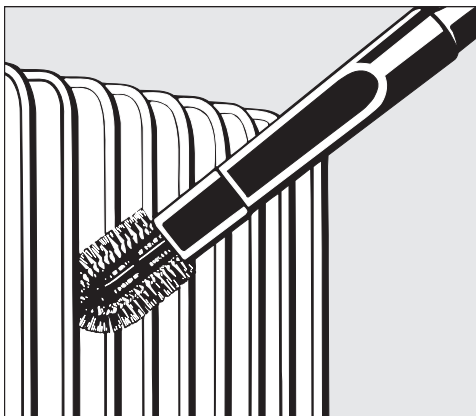

### Universal brush

For dusting books, shelves, etc.



### Dusting brush with horsehair

For dusting particularly delicate objects.

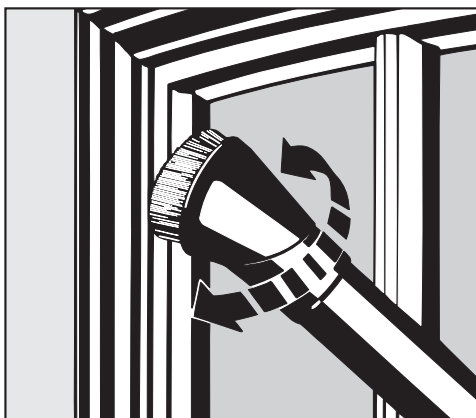

## Accessories available as optional extras

### Mattress nozzle

(standard or optional accessory depending on model)

For easy vacuuming of mattresses and upholstery furniture.



### Crevice nozzle, 300 mm

For cleaning in folds, crevices or corners.

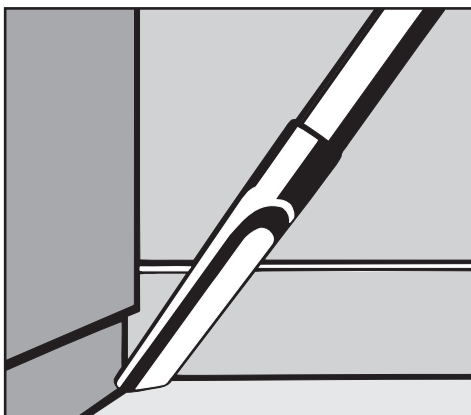

### MicroSet

The set is specially designed for cleaning intricate small objects and difficult to reach areas (such as PC keyboards, stereo equipment, intricately carved furniture and ornaments, models etc).

Accessory set consisting of:

- micro hose with combi nozzle (crevice nozzle and dusting brush)
- micro dusting brush
- micro crevice nozzle and
- angled extension

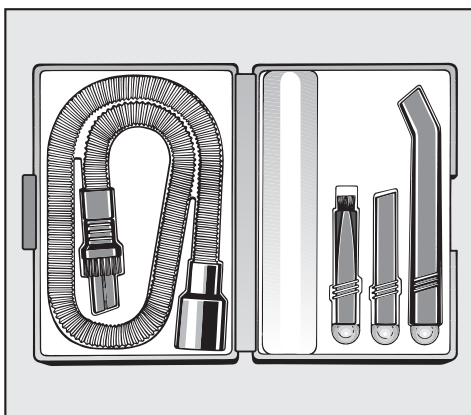

## Accessories available as optional extras

### ACTIVE air clean filter

(standard or optional accessory depending on model)

This is a special active charcoal filter which absorbs odours from the dust collected in the dustbag. It helps, therefore, to prevent the build up of odours occurring.

The "ACTIVE air clean filter" can replace the filter already fitted.

Do not use aroma capsules in your vacuum cleaner if it is fitted with this filter.

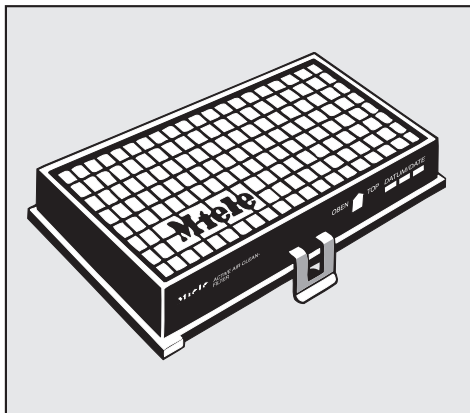

### ACTIVE HEPA filter

(standard or optional accessory depending on model)

This is a particle filter conforming to EN 1822 HEPA Classification 12. It is able to filter out very fine particles and micro-organisms. The active charcoal layer absorbs odours from the dust collected in the dustbag.

Vacuum cleaners equipped with this exhaust filter are particularly suitable for allergy sufferers and those concerned with a high level of hygiene.

Do not use aroma capsules in your vacuum cleaner if it is fitted with this filter.

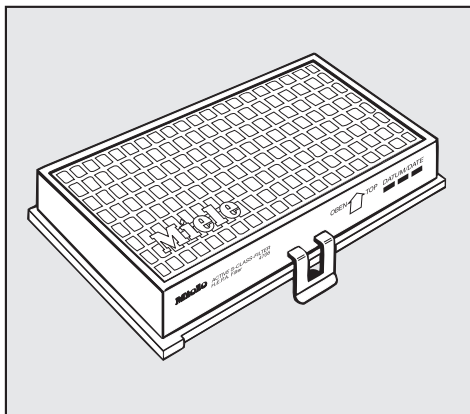



All electrical work should be carried out by a suitably qualified and competent person in strict accordance with national and local safety regulations.

The voltage, rated load and fuse rating are given on the data plate located underneath the vacuum cleaner. Please ensure that these match the household mains supply.

The appliance is supplied with a cable and moulded plug ready for connection to a 230-240 V/50 Hz a.c. single phase supply. The fuse rating is 13 A.

If the plug fitted is not suitable it must be replaced by one that is.

## **Non-rewireable plugs BS 1363**

If this machine or appliance is fitted with a non-rewireable plug, the following information applies: if the socket outlets are not suitable for the plug supplied with this product, it must be cut off and an appropriate plug fitted. The fuse carrier and fuse should be removed from the old plug and disposed of. The plug cut from the flexible cord should then be disposed of and on no account be inserted into any socket elsewhere in the house (electric shock hazard). The fuse cover must be re-fitted when changing the fuse, and if the fuse cover is lost the plug must not be used until a suitable replacement is obtained. The colour of the correct replacement cover is that of the coloured insert in the base of the plug, or the colour that is embossed in words on the base of the plug, (as applicable to the design of plug fitted).

The correct rating of the replacement fuses that are ASTA approved to BS 1362 should be fitted. Replacement covers may be purchased from your local electrical supplier, electricity showroom or Miele service agent.

## **Important**

The wires in the mains lead of this appliance are coloured in accordance with the following code:

### **Blue = Neutral**

### **Brown = Live**

As the colours of the wires may not correspond with the markings identifying the terminals in your plug, proceed as follows: The wire coloured blue must be connected to the terminal marked with the letter "N" or coloured black. The wire coloured brown must be connected to the terminal marked with the letter "L" or coloured red. Neither core is to be connected to the earth terminal of a three-pin plug.







**United Kingdom:**

Miele Co. Ltd.

Fairacres, Marcham Road, Abingdon, Oxon, OX14 1TW

tel. Abingdon (01235) 554455 - fax (01235) 554477

Service Office, tel. Abingdon (01235) 554466

Internet: [www.miele.co.uk](http://www.miele.co.uk)

**Ireland:**

Miele Ireland Ltd.

Broomhill Road, Tallaght, Dublin 24

Tel: (01) 46 10 710, Fax: (01) 46 10 797

Email: [info@miele.ie](mailto:info@miele.ie)

Internet: <http://www.miele.ie>